

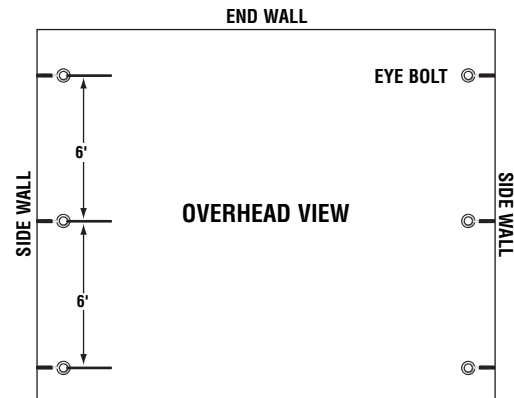

Batting Cage Net #10 Indoor Installation Instructions

Available in Dark Green Only

1. Attach the eye bolts to your gym walls. Arrange these eye bolts at each end of your gym in the following manner.



2. SIDEWALL VIEW: EYE BOLT POSITIONING

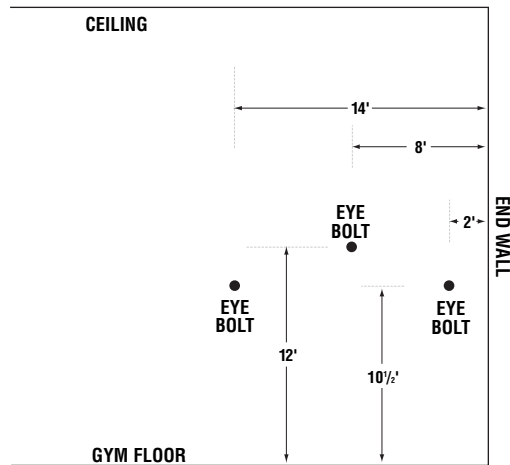

3. Attach the cables as follows: OVERHEAD VIEW

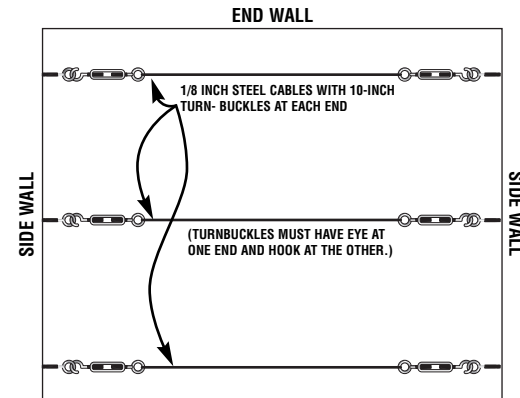

4. Hang up your net by attaching the net's thick Poly-Dac rope to the cables by means of snap rings. Rings should be 18" apart.

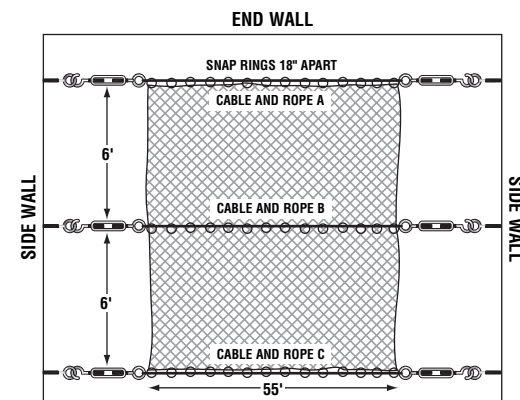

5. SIDE VIEW OF NET IN PLACE

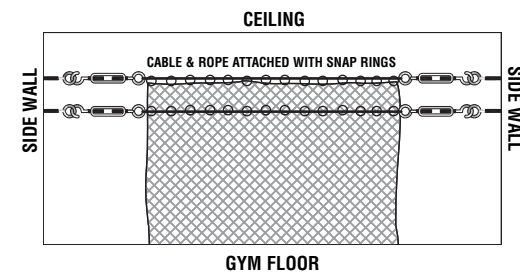

6. "BATTER'S VIEW" OF CAGE #2 (Indoors)

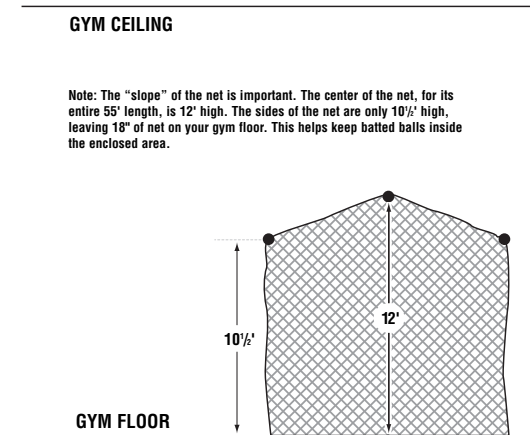

7. To store your net, simply slide it along the cables to side wall.

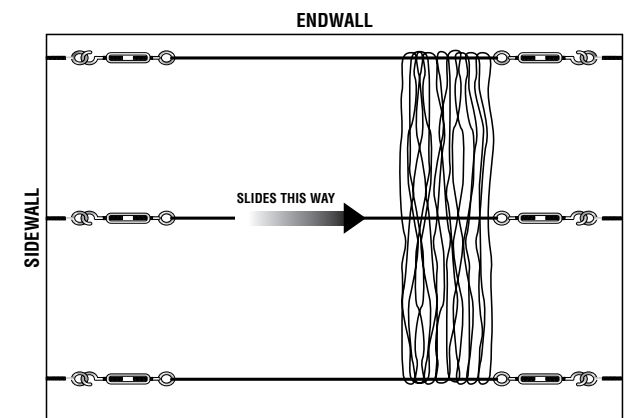

8. If you want to take your net down, follow these steps:

1. After you have your net in the "ready-to-be-moved" position, slide the net down to one end. (See drawing above.)
2. Then, unhook the cables at the other end. (In other words, the end furthest away from the net.)
3. Wrap the cables around the net.
4. Unhook remaining turnbuckles.
5. Store net in closet.

HOW TO ATTACH YOUR NETTING TO THE CABLES

1. The cables should be placed and tightened to your frame sections or walls.
2. Stretch out your net on the ground underneath the cables.
3. Starting at one end, while on a ladder or platform, have your partner hand up to you the end of the net.
4. Attach the rope border, on top of the net, to the cables by opening the snap rings and putting the rope and cable inside. Repeat this every 18" having your partner continue to "feed" you the net until one side is completed.
5. Repeat steps 3 and 4 for the middle and opposite side cable.

Note: You should have to go up and down the ladder only 3 times, once for each of the cables.

HOW TO ATTACH YOUR CABLES TO THE EYE BOLTS

1. Cut cable to appropriate length.
2. Run one end of your cable through the turnbuckle and secure using cable clamp. Tape end of cable to prevent fraying.
3. Hook turnbuckle on to eye bolt extending from the wall or frame section.
4. Repeat steps 2 and 3 at opposite end.
5. Tighten the turnbuckles at each end of the cable to provide tension to hold up the net.

Note: You should provide for extra cable length when setting up initially. You can always cut off excess cable if not needed.

Close-up view of the eye bolt, turnbuckle, cable clamp, cable, and snap rings assembled:

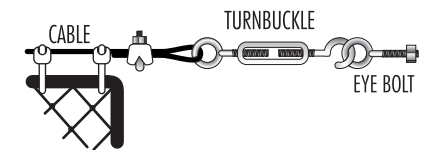

CUSTOM NETTING of all shapes and sizes now available, including: Batting Cage Nets, Backstops, Trapezoid Backstops, Outfield and Foul Ball Netting.

There are 3 Ways for you to get more information and FREE estimates on JUGS Custom Netting:

1. Call JUGS at 1-800-547-6843 and ask for a Net Specialist.
2. FAX your specifications to a Net Specialist at 503-691-1100.
3. E-mail your specifications to jims@jugssports.com.

From factory to You in LESS THAN 2 WEEKS

NOTE: Drawings are not to scale.

WARNING: Do not leave your net and frame up during extreme weather conditions (high wind, snow), as non-warranty damage may occur.

www.jugssports.com



Batting Cage Net #10 Outdoor Installation Instructions

381-lb. Breaking-Strength Knotted-Nylon Twine • Two-Year Guarantee, Available in Dark Green Only

1. Once you assemble them, the end sections will look like this. Insert a short hanging-loop assembly into each of three pre-drilled crossbar holes.

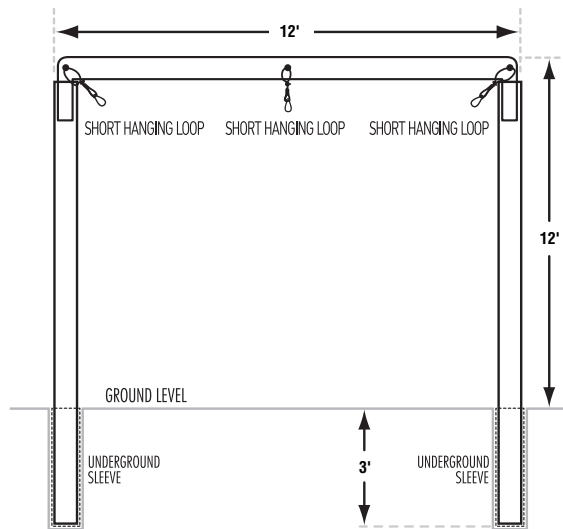

2. Once you assemble them, the two middle sections will look like this. On both insert a short hanging-loop assembly into the middle pre-drilled crossbar hole and long hanging-loop assemblies into the outside pre-drilled crossbar holes.

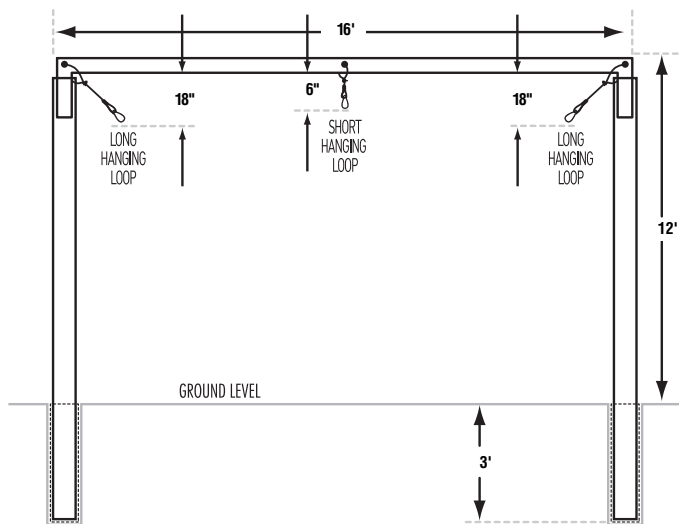

NOTE: Drawings are not to scale.

3. OVERHEAD VIEW OF WHERE TO DIG HOLES FOR THE GROUND SLEEVES.

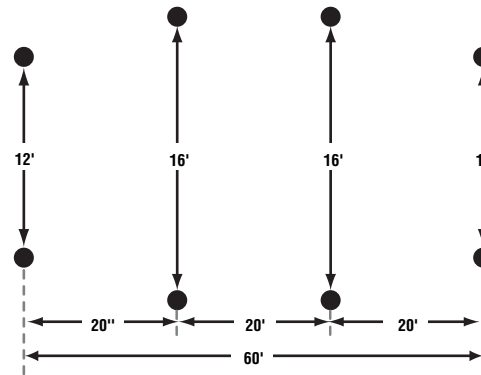

4. SIDE VIEW OF THE FOUR U-SHAPED SECTIONS COMPLETELY SET UP.

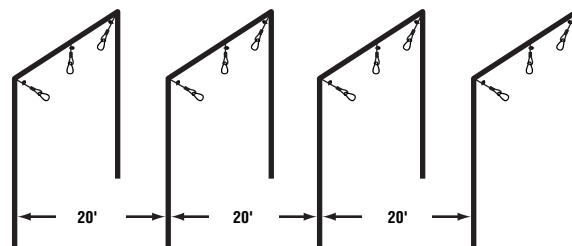

5. SIDE VIEW OF NET COMPLETELY SET UP

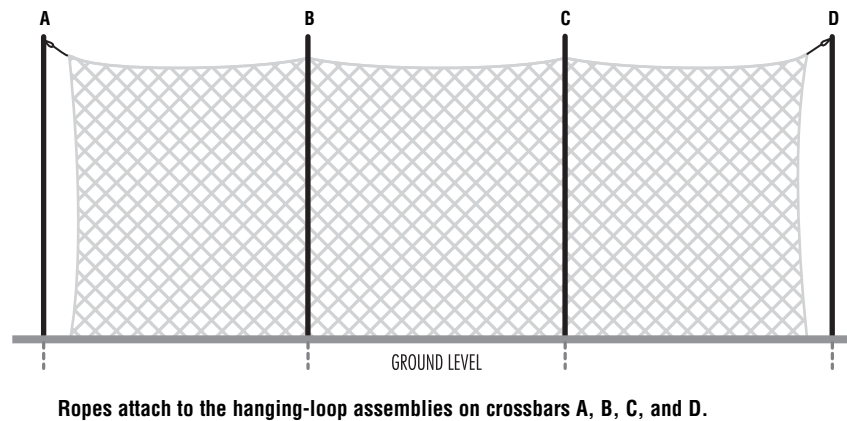

HOW TO SET UP YOUR JUGS OUTDOOR FRAME

1. Check contents to make sure you have all needed parts.

Tubing:

- Eight - 1⁷/₈" x 15'-long galvanized tubing
- Eight - 2³/₈" x 3'-long galvanized tubing (ground sleeves)
- Two - 1⁵/₈" x 12'-long galvanized tubing
- Two - 1⁵/₈" x 16'-long galvanized tubing

Hanging-Loop Assemblies:

- Twelve - hanging-loop assemblies (Four long hanging-loop assemblies and Eight short hanging-loop assemblies)

2. Dig holes and secure the 3' sleeves into the ground. Use concrete to secure your 3' sleeves into the ground.

3. **End Sections:** Insert a **short** hanging-loop assembly into each of three pre-drilled crossbar holes and secure all with cable clamps.

Middle Sections: Insert a **short** hanging-loop assembly into each of the middle pre-drilled crossbar holes and **long** hanging-loop assemblies into the outside pre-drilled crossbar holes and secure all with cable clamps.

4. Slide the middle 12' crossbars into the uprights and fit into the sleeves.

5. Slide the end 16' crossbars into the uprights and fit into sleeves.

You are now ready to attach your netting to the frame.

HOW TO ATTACH YOUR JUGS NET TO THE FRAME

1. Lay your net out under the frame sections. Stretch it out completely from one end to the other.

2. Pick up the net by the nylon rope and attach it to the middle frame sections with the hanging-loop assemblies.

3. After hanging the net on the middle frame sections, making sure that it does not sag more than 1-2', pull the ropes towards the end frames to stretch it out. Attach each rope to the end frame sections with the corresponding hanging-loop assemblies. **See Figure 1.**

4. Walk completely around the net, pulling and helping the net to stretch into shape.

The net will condense inside the box and will need a little help getting back into shape.

We at JUGS recommend hanging your batting cage net with a minimum of 18" of netting on the ground. This will provide you with enough net and weight to prevent balls from slipping out underneath the sides and ends of the net.

You should not stake the net down or put any type of weight on the net to hold it down. This would cause the net to prematurely wear out because the net would not be allowed to "give" and absorb the batted balls.

Remember: For safety purposes, your net should be at least 2' away from all poles or hard surfaces. That way, none of the batted balls can bounce back and injure someone.

HOW TO ATTACH YOUR HANGING LOOPS TO THE CROSSBARS

1. At each pre-drilled hole on the crossbar, hold the clamp and hanging-loop assembly with one hand and thread the cable through the pre-drilled hole with your other hand.

2. Wrap the cable around the crossbar and thread it back down into the cable clamp.

3. Slide the cable clamp up on the cable and tighten it, leaving one inch of cable hanging below. **See Figure 2.**

CUSTOM NETTING of all shapes and sizes now available, including: Batting Cage Nets, Backstops, Trapezoid Backstops, Outfield and Foul Ball Netting.

There are **3** Ways for you to get more information and FREE estimates on JUGS Custom Netting:

1. **Call** JUGS at 1-800-547-6843 and ask for a Net Specialist.

2. **FAX** your specifications to a Net Specialist at 503-691-1100.

3. **E-mail** your specifications to jims@jugssports.com.

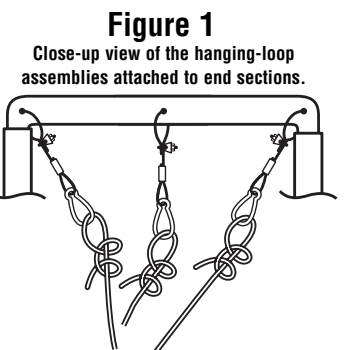

Figure 1
Close-up view of the hanging-loop assemblies attached to end sections.

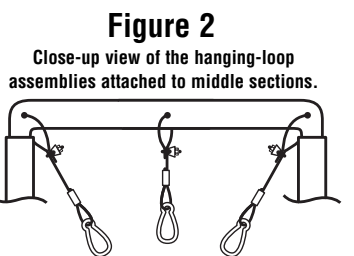

Figure 2
Close-up view of the hanging-loop assemblies attached to middle sections.

From factory to You in LESS THAN 2 WEEKS



WARNING:

Do not leave your net and frame up during extreme weather conditions (high wind, snow), as non-warranty damage may occur.

www.jugssports.com



Batting Cage Net #10 Outdoor Installation Instructions

119-lb. and 191-lb. Breaking-Strength Knotted-Nylon Twine • One-Year Guarantee, Available in Dark Green Only

1. Once you assemble them, the end sections will look like this. Insert a short hanging-loop assembly into each of three pre-drilled crossbar holes.

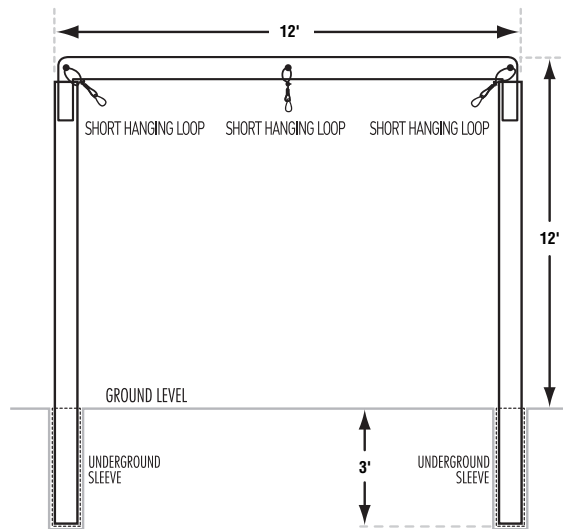

2. Once you assemble it, the middle section will look like this. Insert a short hanging-loop assembly into the middle pre-drilled crossbar hole and long hanging-loop assemblies into both outside pre-drilled crossbar holes.

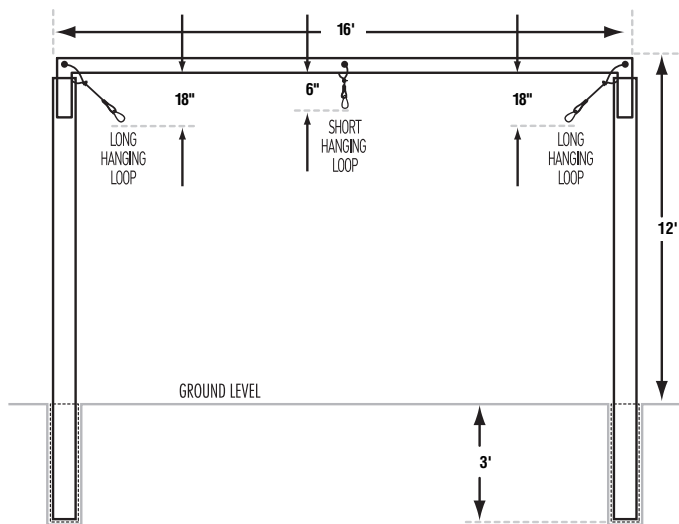

NOTE: Drawings are not to scale.

3. OVERHEAD VIEW OF WHERE TO DIG HOLES FOR THE GROUND SLEEVES.

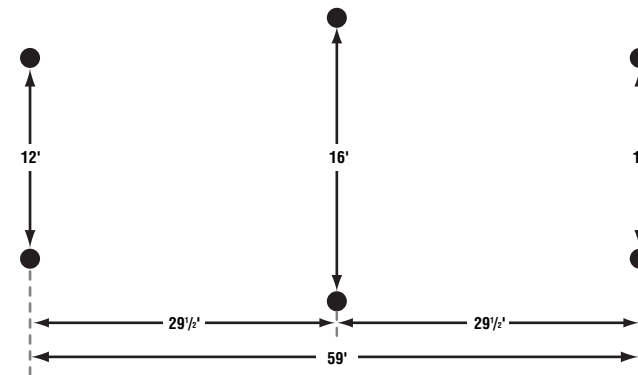

4. SIDE VIEW OF THE THREE U-SHAPED SECTIONS COMPLETELY SET UP.

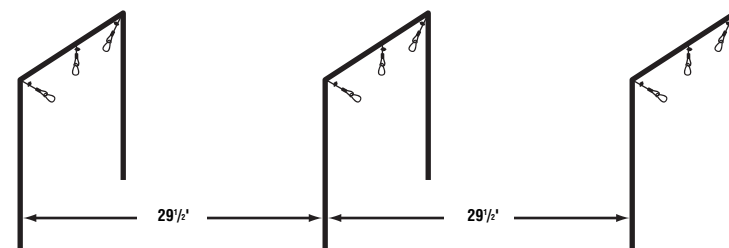

5. SIDE VIEW OF NET COMPLETELY SET UP

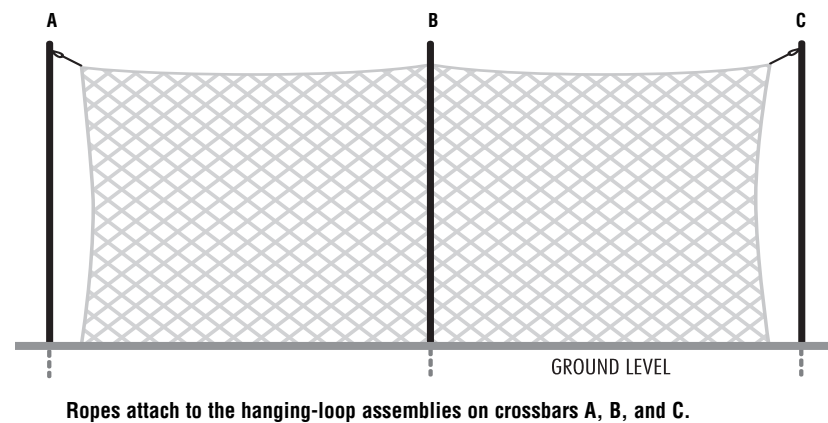

HOW TO SET UP YOUR JUGS OUTDOOR FRAME

1. Check contents to make sure you have all needed parts.

tubing:

- Six - 1 7/8" x 15'-long galvanized tubing
- Six - 2 3/8" x 3'-long galvanized tubing (ground sleeves)
- Two - 1 5/8" x 12'-long galvanized tubing
- One - 1 5/8" x 16'-long galvanized tubing

Hanging-Loop Assemblies:

- Nine - hanging-loop assemblies (Two long hanging-loop assemblies and Seven short hanging-loop assemblies)

2. Dig holes and secure the 3' sleeves into the ground. Use concrete to secure your 3' sleeves into the ground.

3. **End Sections:** Insert a **short** hanging-loop assembly into each of three pre-drilled crossbar holes and secure all with cable clamps.

Middle Section: Insert a **short** hanging-loop assembly into the middle pre-drilled crossbar hole and **long** hanging-loop assemblies into both outside pre-drilled crossbar holes and secure all with cable clamps.

4. Slide the middle 16' crossbars into the uprights and fit into the sleeves.

5. Slide the end 12' crossbars into the uprights and fit into sleeves.

You are now ready to attach your netting to the frame.

HOW TO ATTACH YOUR JUGS NET TO THE FRAME

1. Lay your net out under the frame sections. Stretch it out completely from one end to the other.

2. Pick up the net by the nylon rope and attach it to the middle frame section with the hanging-loop assemblies.

3. After hanging the net on the middle frame section, making sure that it does not sag more than 1-2', pull the ropes towards the end frames to stretch it out. Attach each rope to the end frame sections with the corresponding hanging-loop assemblies. **See Figure 1.**

4. Walk completely around the net, pulling and helping the net to stretch into shape. The net will condense inside the box and will need a little help getting back into shape.

We at JUGS recommend hanging your batting cage net with a minimum of 18" of netting on the ground. This will provide you with enough net and weight to prevent balls from slipping out underneath the sides and ends of the net.

You should not stake the net down or put any type of weight on the net to hold it down. This would cause the net to prematurely wear out because the net would not be allowed to "give" and absorb the batted balls.

Remember: For safety purposes, your net should be at least 2' away from all poles or hard surfaces. That way, none of the batted balls can bounce back and injure someone.

HOW TO ATTACH YOUR HANGING LOOPS TO THE CROSSBARS

1. At each pre-drilled hole on the crossbar, hold the clamp and hanging-loop assembly with one hand and thread the cable through the pre-drilled hole with your other hand.

2. Wrap the cable around the crossbar and thread it back down into the cable clamp.

3. Slide the cable clamp up on the cable and tighten it, leaving one inch of cable hanging below. **See Figure 2.**

CUSTOM NETTING of all shapes and sizes now available, including: Batting Cage Nets, Backstops, Trapezoid Backstops, Outfield and Foul Ball Netting.

There are 3 Ways for you to get more information and FREE estimates on JUGS Custom Netting:

1. **Call** JUGS at 1-800-547-6843 and ask for a Net Specialist.

2. **FAX** your specifications to a Net Specialist at 503-691-1100.

3. **E-mail** your specifications to jims@jugssports.com.

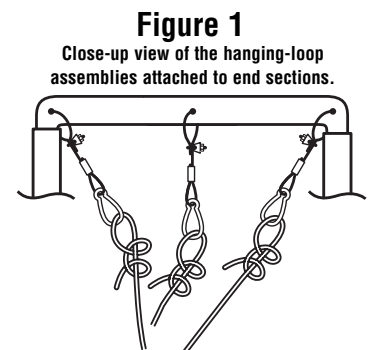

Figure 1
Close-up view of the hanging-loop assemblies attached to end sections.

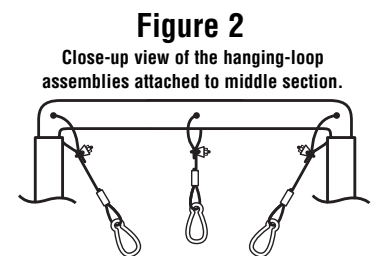

Figure 2
Close-up view of the hanging-loop assemblies attached to middle section.

From
factory to You
in LESS THAN 2
WEEKS

WARNING: Do not leave your net and frame up during extreme weather conditions (high wind, snow), as non-warranty damage may occur.

www.jugssports.com



Batting Cage Net #10 Outdoor **OPTIONAL INSTALLATION KIT** Instructions

119-lb. and 191-lb. Breaking-Strength Knotted-Nylon Twine • One-Year Guarantee, Available in Dark Green Only

1. Here is a drawing of how your frame will look before you set up your cables and hang up your net.

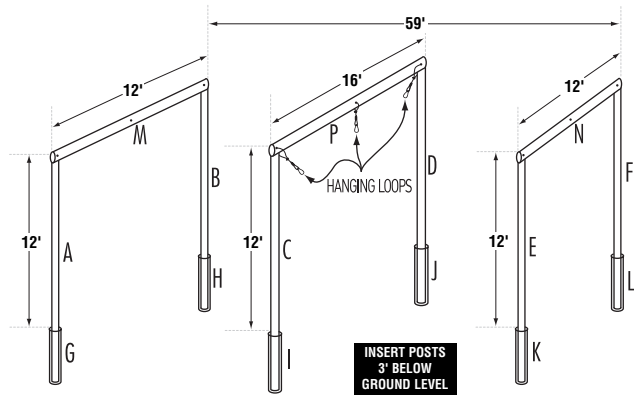

2. Here is a list of the type of tubing and how many of each you will need to install your JUGS Batting Cage Net.

- Six 1 7/8 galvanized tubing – 15' – A, B, C, D, E and F in drawing.
- Six 2 3/8 galvanized tubing – 3' long – G, H, I, J, K, L. These are underground “sleeves.”
- Two 1 5/8 galvanized tubing – 12' long – M and N. These are “end section” crossbars.
- One 1 5/8 galvanized tubing – 16' long – P. This is the middle crossbar.

3. TOP VIEW OF TUBING INSTALLATION

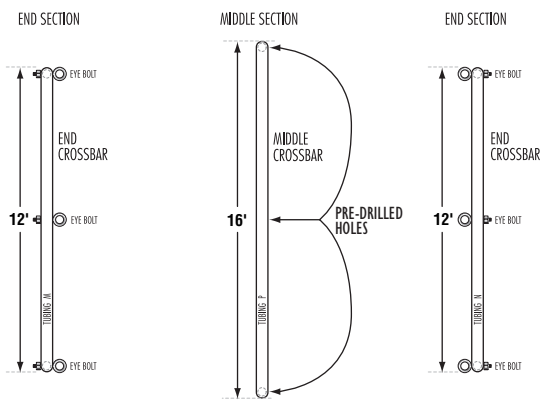

4. FRONT VIEW OF END SECTIONS

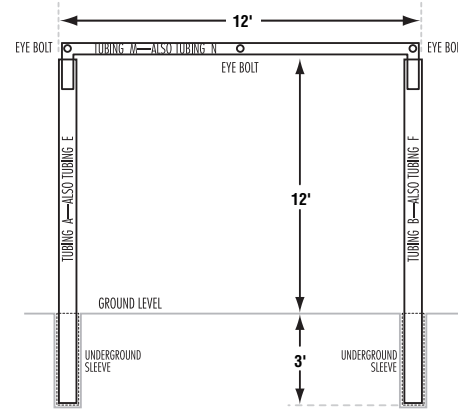

5. FRONT VIEW OF MIDDLE SECTION

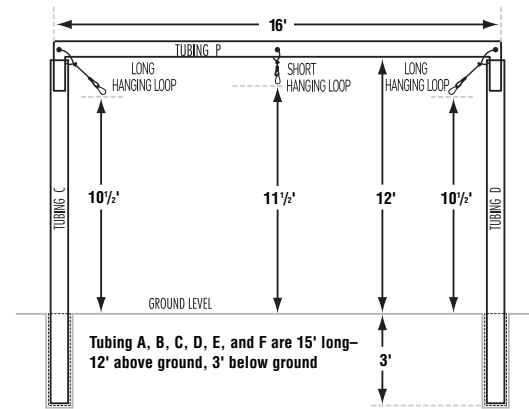

6. TOP VIEW OF CABLES, EYE BOLTS, TURNBUCKLES ETC. IN PLACE

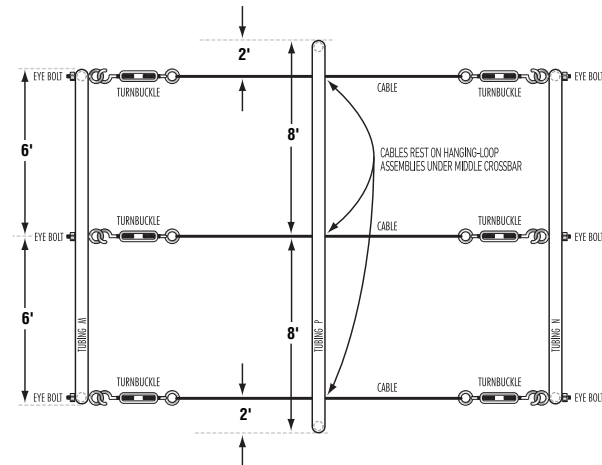

7. DETAILS OF END CROSSBARS

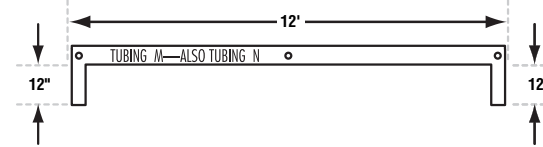

8. DETAILS OF MIDDLE CROSSBAR

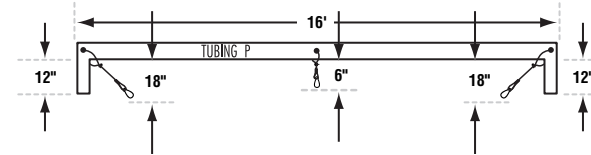

9. OVERHEAD VIEW OF NET IN PLACE

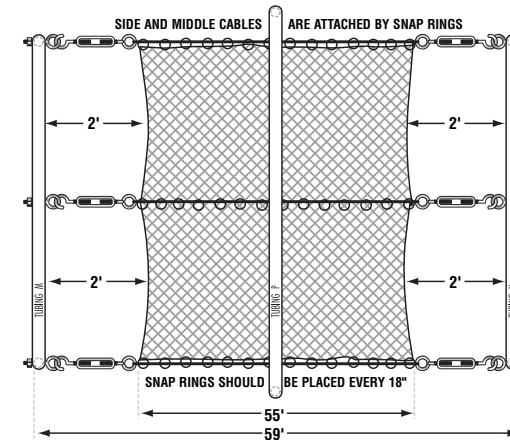

10. SIDE VIEW OF NET IN PLACE

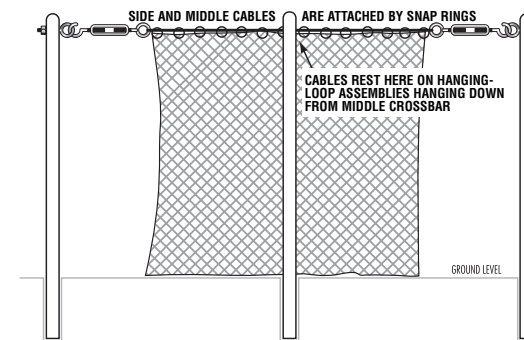

NOTE: Drawings are not to scale.

HOW TO ATTACH YOUR NETTING TO THE CABLES

1. The cables should be placed and tightened to your frame sections or walls.
2. Stretch out your net on the ground underneath the cables.
3. Starting at one end, while on a ladder or platform, have your partner hand up to you the end of the net.
4. Attach the rope border, on top of the net, to the cables by opening the snap rings and putting the rope and cable inside. Repeat this every 18", having your partner continue to "feed" you the net until one side is completed.
5. Repeat steps 3 and 4 for the middle and opposite side cable.

Note: You should have to go up and down the ladder only three times, once for each of the cables.

HOW TO ATTACH YOUR CABLES TO THE EYE BOLTS

1. Cut cable to appropriate length.
2. Run one end of your cable through the turnbuckle and secure using cable clamp. Tape end of cable to prevent fraying.
3. Hook turnbuckle on to eye bolt extending from the wall or frame section.
4. Repeat steps 2 and 3 at opposite end.
5. Tighten the turnbuckles at each end of the cable to provide tension to hold up the net.
6. Important: Tighten the cables so that they rest in cable hooks. (See diagrams #5 and #6.)
Do not tighten cables any tighter or you will risk bending the pipes.

Note: You should provide for extra cable length when setting up initially. You can always cut off excess cable if not needed.

Close-up view of the eye bolt, turnbuckle, cable clamp, cable, and snap rings assembled:

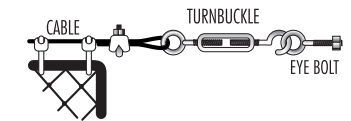

HOW TO ATTACH YOUR HANGING LOOPS TO THE MIDDLE CROSSBAR

1. Slide a cable clamp onto each of the three hanging-loop assemblies—two with longer cables and one with a shorter cable. You will attach the two longer ones near the ends of the crossbar and the shorter one at the center of the crossbar.
2. At each pre-drilled hole on the crossbar, hold the clamp and hanging-loop assembly with one hand and thread the cable through the pre-drilled hole with your other hand.
3. Wrap the cable around the crossbar and thread it back down into the cable clamp.
4. Slide the cable clamp up on the cable and tighten it, leaving one inch of cable hanging below.

Close-up view of the hanging-loop assemblies attached to middle and corners of the middle crossbar:

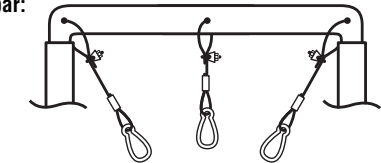

CUSTOM NETTING of all shapes and sizes now available, including: Batting Cage Nets, Backstops, Trapezoid Backstops, Outfield and Foul Ball Netting.

There are 3 Ways for you to get more information and FREE estimates on JUGS Custom Netting:

1. Call JUGS at 1-800-547-6843 and ask for a Net Specialist.
2. FAX your specifications to a Net Specialist at 503-691-1100.
3. E-mail your specifications to jims@jugssports.com.

From factory to You in LESS THAN 2 WEEKS

WARNING: Do not leave your net and frame up during extreme weather conditions (high wind, snow), as non-warranty damage may occur.

www.jugssports.com